

DOMINO-180MA-DR-DIM - Dimmable LED Driver

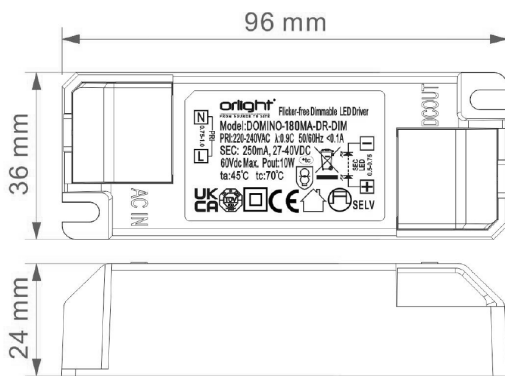

Dimensions



Description

DOMINO-180MA-DR-DIM is a constant current LED driver dimmable via leading edge and trailing edge phase dimmers with short-circuit protection and self-recovery function.

Specification

Mains dimming	Leading & Trailing edge phase dimmers
Rated Supply Voltage	220 - 240V
Input Voltage AC	185 - 264V
Mains Frequency	47 - 63Hz
Max. Power	7.2W
Power Factor [@230V, 50Hz full load]	0.9
Typ. Efficiency [@230V, 50Hz full load]	74%
THD [@230V, 50Hz full load]	<15%
Starting time	<0.55s @ 230V
Leakage current	<2mA
Output current [fixed]	180mA
Min / Max forward voltage, DC	27 - 40V
Type of protection	IP20
Operating temperature	-25 °C to +45 °C
Storage temperature & humidity	-40 °C to +80 °C 10% RH no condensation
Lifetime	>50,000 hrs
Guarantee	2 years
Dimensions L x W x H	96mm x 36mm x 24mm
Net weight	44g
Standards	IEC 61347-2-13:2014, AMD1:2016 used in conjunction with IEC 61347-1:2015, AMD1:2017.
	IEC 60598-2-1:2020 used in conjunction with IEC 60598-1:2020.
	IEC 62493 [ED2]
EN61000-4-2,3,4,5,6,8,11; EN61547	
Test procedure	TUV mark, E-LVD & UKCA

Product Coding Example: DOMINO-180MA-DR-DIM

CODE

DOMINO-180MA-DR-DIM